



**EcoFX**  
LED lighting solutions

# LED Spot Light

Application Occasions:

Mainly used for bridges, buildings, parks, plazas, streets and other public places, also for advertising boards and stage settings.



RGB



Single Lighting



**EFX-XJRS1** 6/3

**EFX-XJRS2** 3/1



Modern and fashionable design makes the lights an artwork, perfectly combined with the environment. The light is mainly made of high-pressed die-casting materials with anti-aging and antistatic spray surface treatment, resulting in eminent self-clean and anticorrosive performance.

Steel glass cover with high strength can well resist impact. Also, the light can allocate white light or single RGB, leading to pure and gorgeous lighting effects. Moreover, light shade and lens insertor are set to meet different needs. And various beam angle designs cater to distinct environment requirements.

## EFX-XJRS1-6

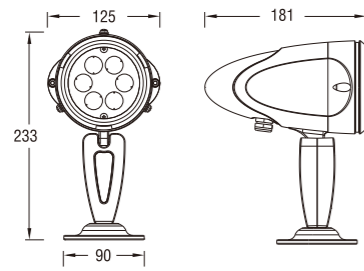

Product Dimension



## EFX-XJRS1-3

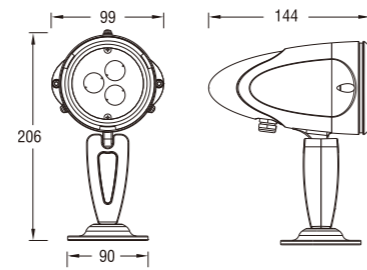

Product Dimension

### Product Description

1. Modern and fashionable design makes the lights an artwork, perfectly combined with the environment.
2. The light is mainly made of high-pressed die-casting materials with anti-aging and antistatic spray surface treatment, resulting in eminent self-clean and anticorrosive performance.
3. Steel glass cover is used, making the light more impact-resistant.
4. The light can allocate white light or Single RGB, causing pure and gorgeous lighting effects, more changeable.



Ground insert



Light Cover



360° adjustable in horizontal direction.



forward elevation 15°, backward elevation 30°

### Installation size

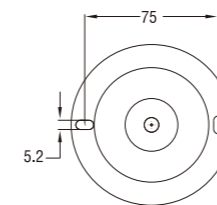

### Light Distribution Curve

#### EFX-XJRS1-6

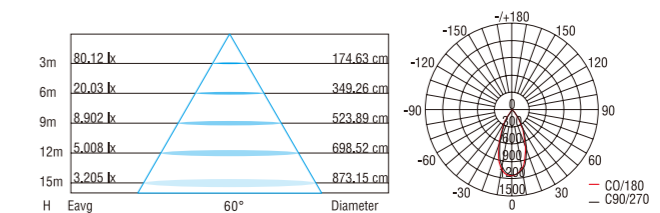
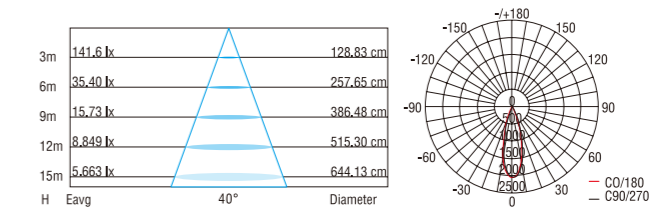
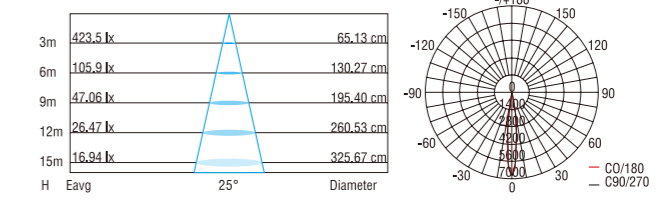
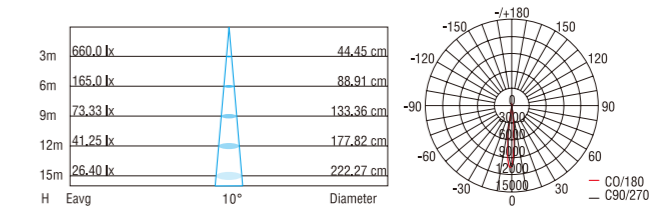

#### EFX-XJRS1-3

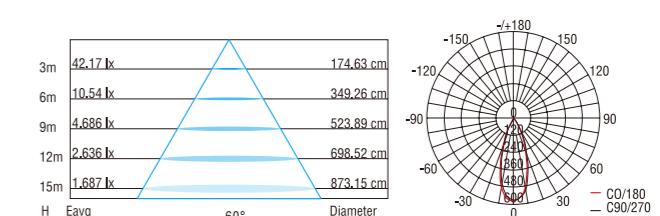
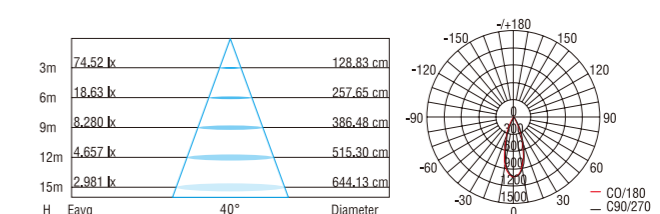
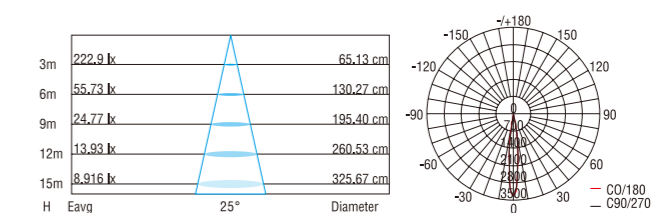
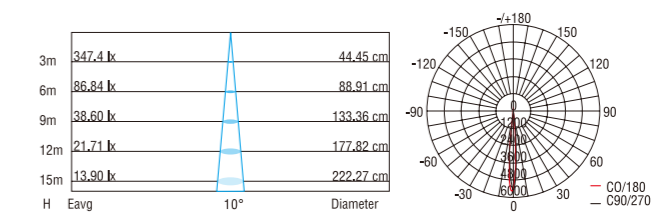





## EFX-XJRS2-3

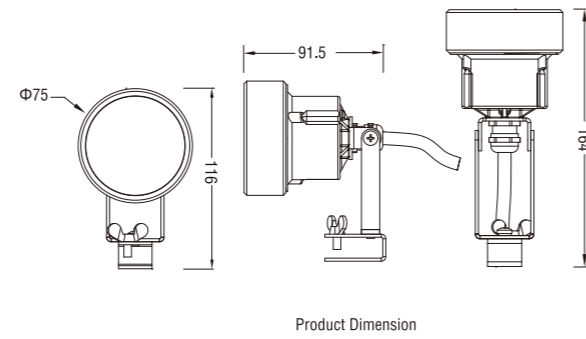

### Product Description

1. With the Independent intellectual properties in design, fashionable and modern appearance, making the lamps to be an artwork and perfectly combined with the environment.
2. The lamp adopts the high-pressure die-casting aluminum material. Surface treated with electrostatic plastic-sprayed in order to anti-aging. Self-cleaning and corrosion- resistance.
3. The diffuser is made of toughened glass, impact resistance.
4. The lamp body can be used in white and RGB, the light effect is good, pure.

### Light Distribution Curve

#### EFX-XJRS2-3

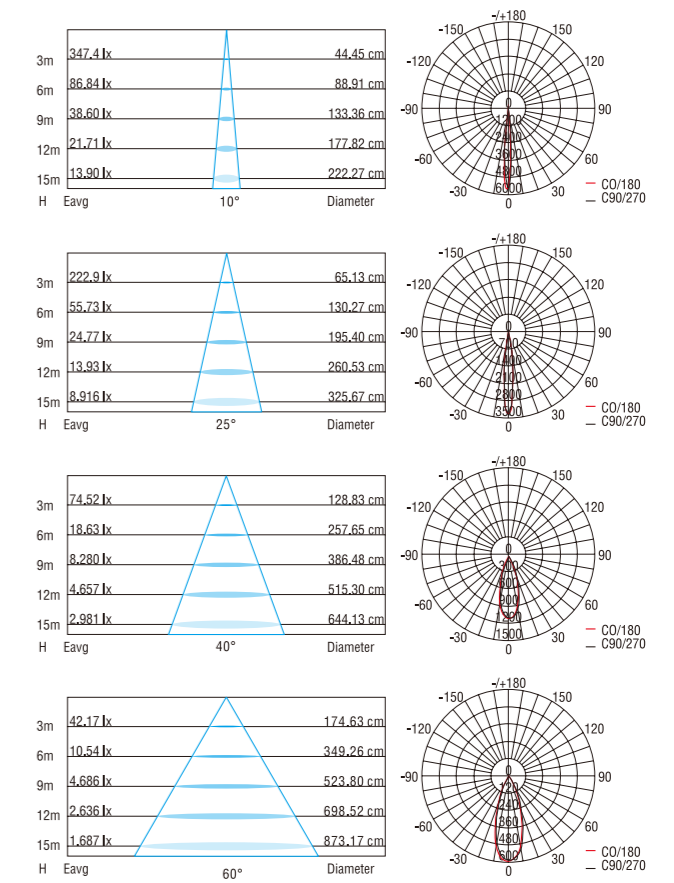

## EFX-XJRS2-1A EFX-XJRS2-1B

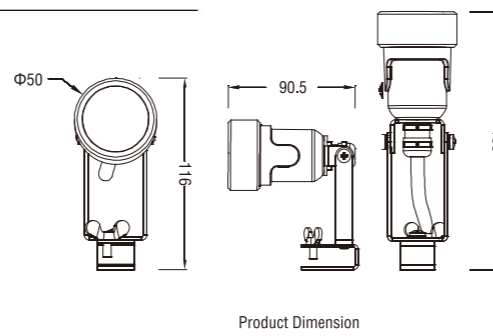

#### EFX-XJRS2-1A

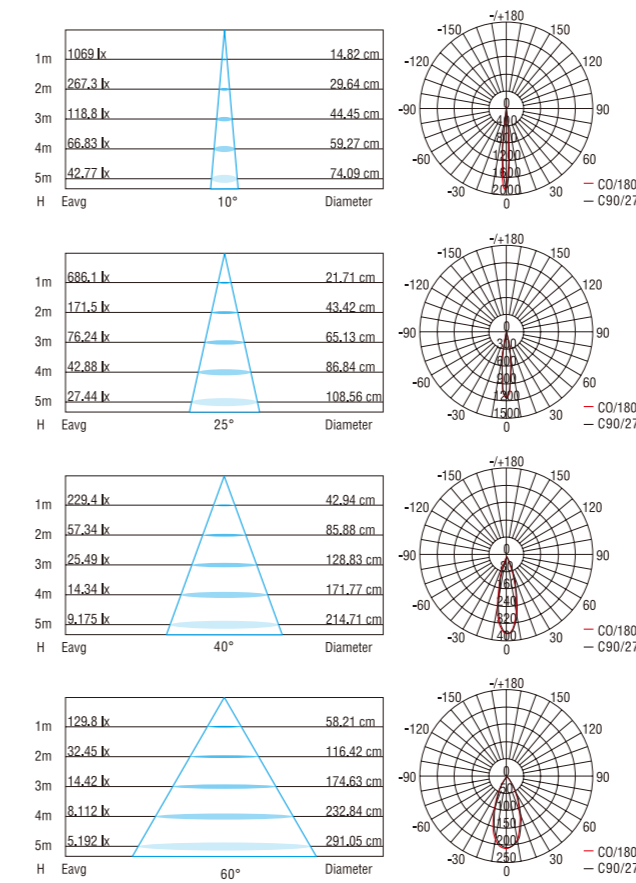

#### EFX-XJRS2-1B

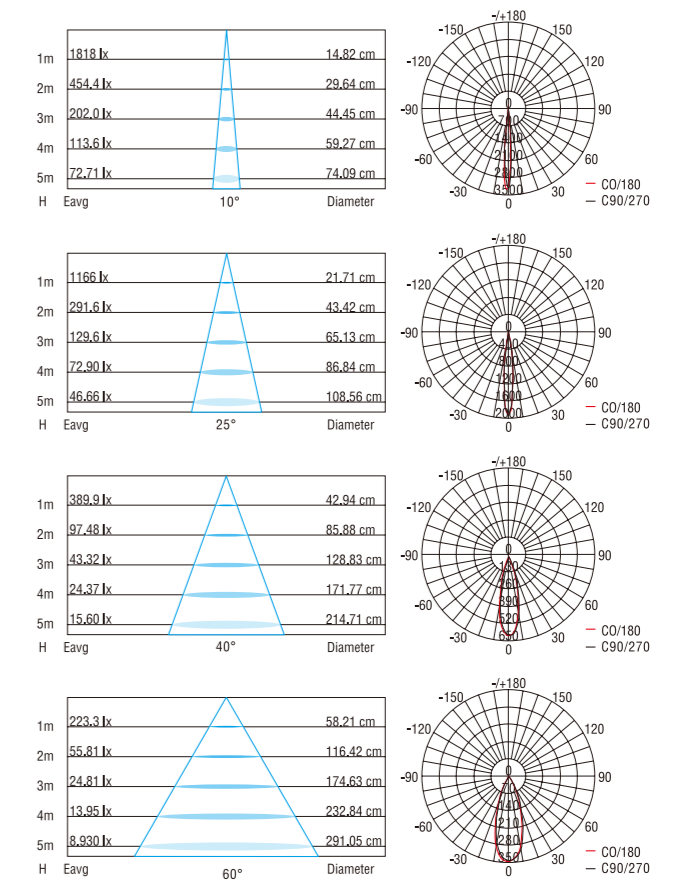

**Specification**

Product Code	EFX-XJRS1-6	EFX-XJRS1-3
LED Quantity	6pcs	3pcs
Rated Power	8.3W	4.2W
Input Voltage	AC100-240V/DC24V	AC100-240V/DC24V
Color	W/R/G/B	W/R/G/B
Beam Angle	10°25°40°60°	10°25°40°60°
Lamp Luminous Flux	472 lm	248 lm
Working Ambient Temperature	-25°C~50°C	-25°C~50°C
Working Ambient Humidity	10%~90%	10%~90%
Life	> 30000H	> 30000H
Protection Grade	IP65	IP65
Net Weight	1.2 /21.6	0.9 /16.2
Gross Weight	1.3 /23.4	1.0 /18.0
Packing Size(mm)	220×170×265 515×445×820 18	200×150×245 465×415×760 18

Product Code	EFX-XJRS2-3	EFX-XJRS2-1A	EFX-XJRS2-1B
LED Quantity	3pcs	1pcs	1pcs
Rated Power	4.2W	2.0W	4.2W
Input Voltage	AC100-240V/DC24V	AC100-240V/DC24V	AC100-240V/DC24V
Color	W/R/G/B	W/R/G/B	W/R/G/B
Beam Angle	10°2 40°60°	10°25°40°60°	10°25°40°60°
Lamp Luminous Flux	248 lm	85 lm	144 lm
Working Ambient Temperature	-25°C~50°C	-25°C~50°C	-25°C~50°C
Working Ambient Humidity	10%~90%	10%~90%	10%~90%
Life	> 30000H	> 30000H	> 30000H
Protection Grade	IP67	IP67	IP67
Net Weight	0.4 /30	0.3 /27	0.3 /27
Gross Weight	0.6 /45	0.4 /36	0.4 /36
Packing Size(mm)	95×80×105 545×435×390 18	95×80×105 545×435×390 18	110×55×110 595×380×390 18

All parameters are measured at 25°C ambient temperature, 35% humidity experimental environment

**Wiring Diagram**

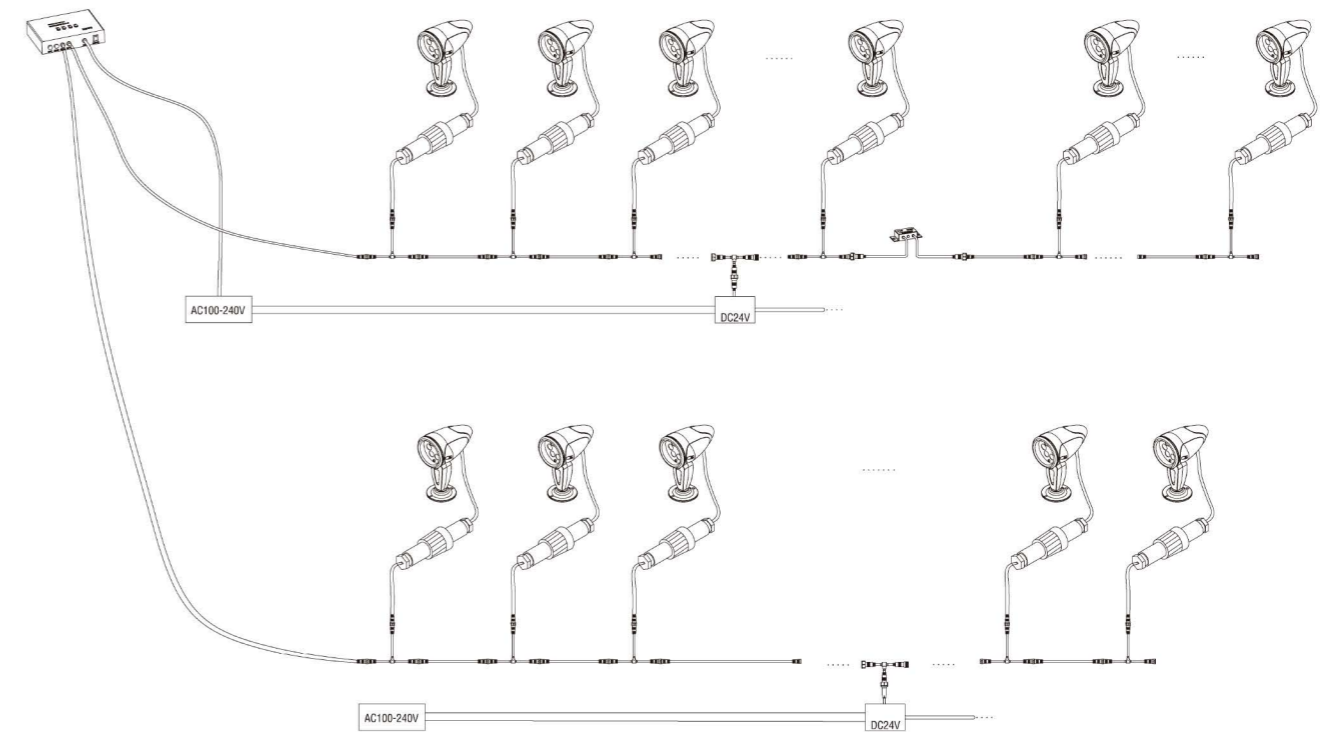

**Accessories**





# LED Spot Light

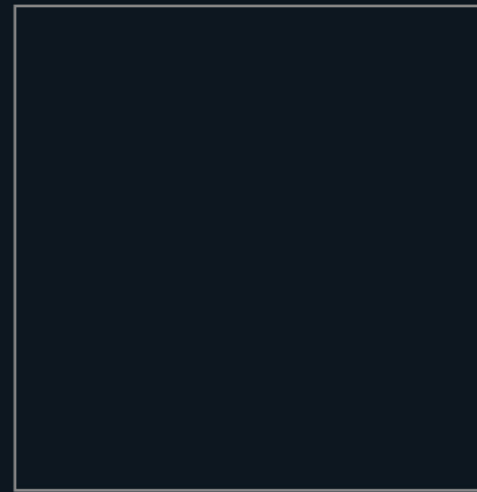
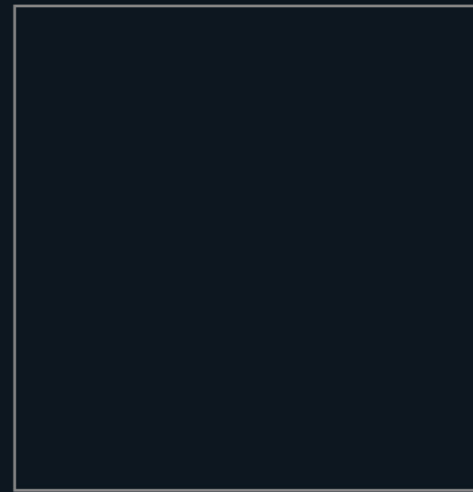
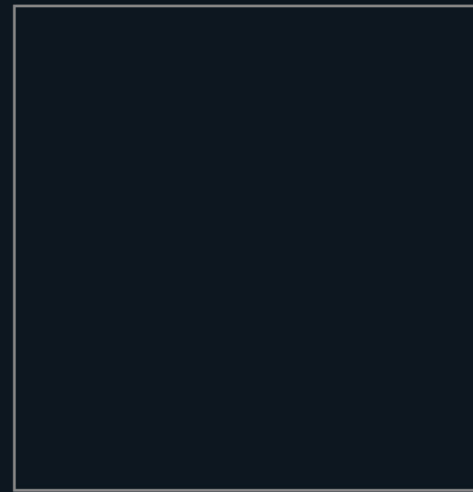
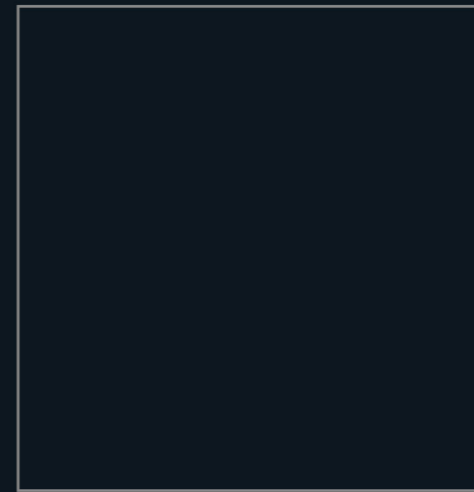

[www.eco-fx.co.uk](http://www.eco-fx.co.uk)

**EcoFX**

LED lighting solutions

Office 1, 192 Shoreham Street  
Sheffield S1 4SQ, UK

**T: +44(0) 114 321 9610**

**E: [enquiries@eco-fx.co.uk](mailto:enquiries@eco-fx.co.uk)**

Global Partner

**Eco-FX**

Smarter LED Lighting Solutions

Australia

