



EcoFX
LED lighting solutions

LED Underwater Light

The Application of Occasions:
Mainly used for underwater lighting like fountain and waterfall, also spot light for rockery and bridge.



RGB

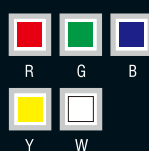

Single Lighting



EFX-XJRH2 36/18/12/9/6/3

EFX-XJRH2 underwater light series adopts special water grain cover design, it fit for the concept for the underwater light. It adopts stainless steel castable material, airproof is good, untirust is strong.double cover and sealed structure technology could ensure the better waterproof function. Double base installation could fit for different installation way.

EFX-XJRH2-36

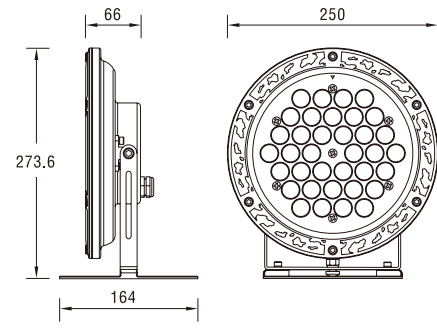

Product Dimension



EFX-XJRH2-18

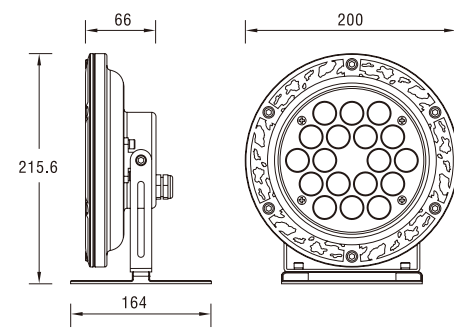

Product Dimension

Product Description

1. With the independent intellectual properties in design, fashionable and modern appearance, making the lights to be an artwork and perfectly combined with the environment.
2. The light adopts the high-pressure die-casting steel material. Surface treated with electrostatic plastic-sprayed in order to anti-aging, Self-cleaning and corrosion-resistance.
3. The diffuser is made of toughened glass, impact resistance.
4. Light fitting can allocate white or single RGB. Various of color available. EFX-XDMX 512 control available.

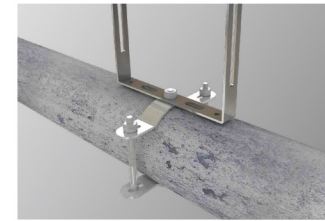

Installation 1 embrace hoop

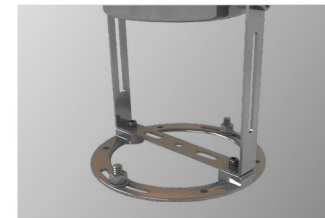

Installation 2 plane



Water proof connector design



Adjustable Angle

Light Distribution Curve

EFX-XJRH2-36

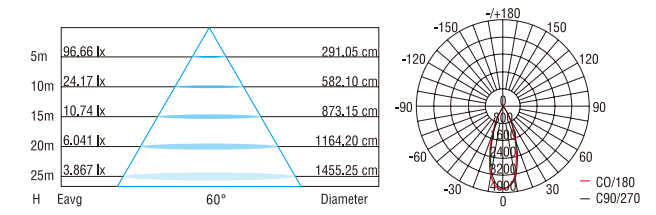
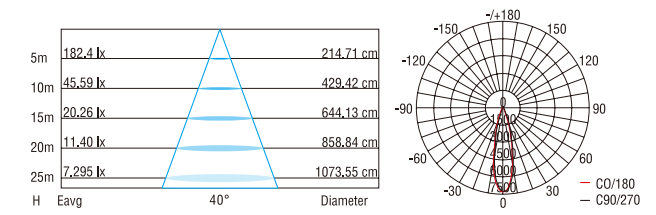
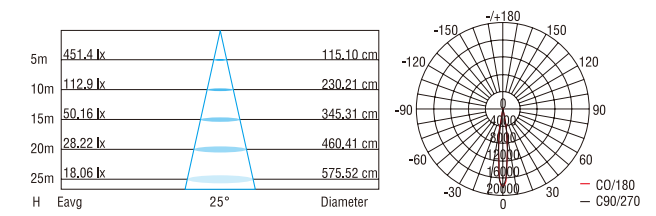
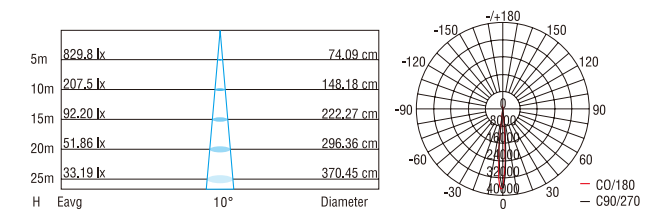

EFX-XJRH2-18

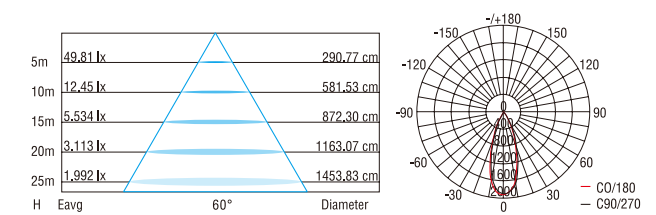
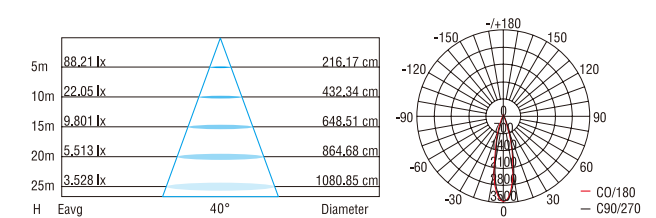
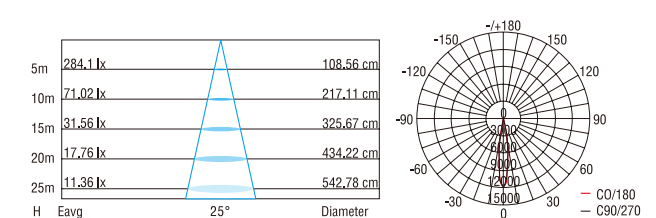
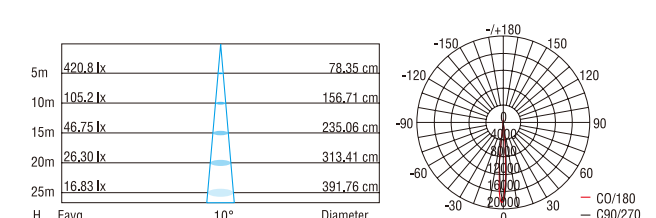

EFX-XJRH2-12

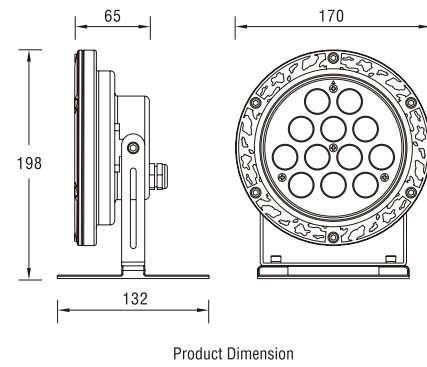

EFX-XJRH2-9

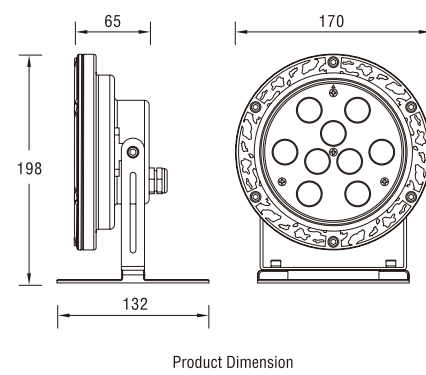

Product Description

1. With the independent intellectual properties in design, fashionable and modern appearance, making the lights to be an artwork and perfectly combined with the environment.
2. The light adopts the high-pressure die-casting steel material. Surface treated with electrostatic plastic-sprayed in order to anti-aging. Self-cleaning and corrosion-resistance.
3. The diffuser is made of toughened glass, impact resistance.
4. Light fitting can allocate white or single RGB. Various of color available. EFX-XDMX 512 control available.

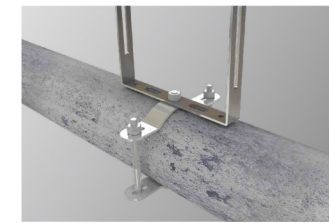

Installation 1 embrace hoop

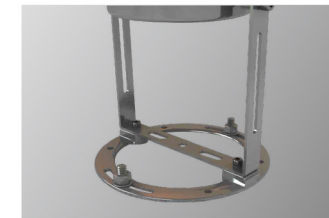

Installation 2 plane



Water proof connector design



Adjustable Angle

Light Distribution Curve

EFX-XJRH2-12

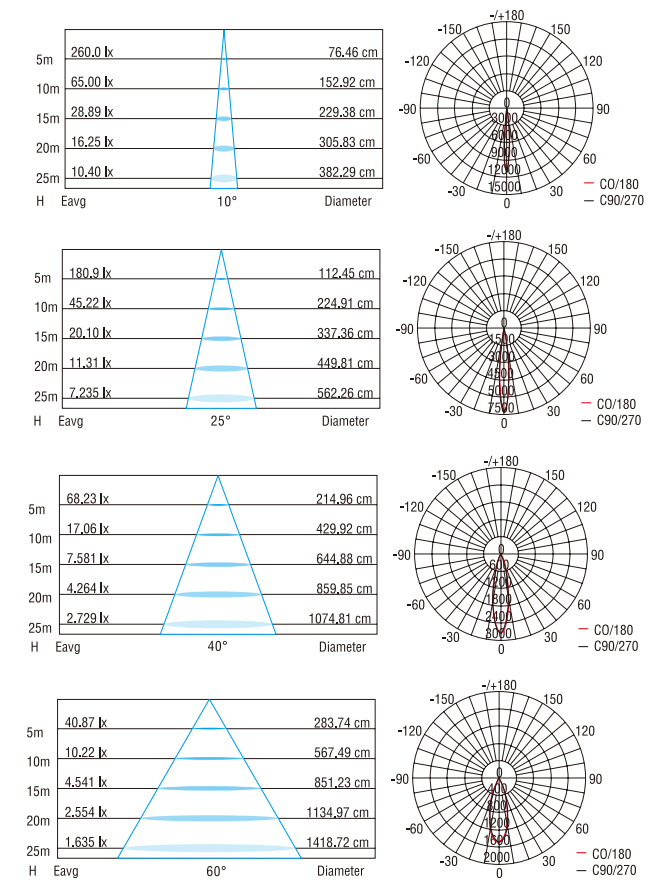

EFX-XJRH2-9

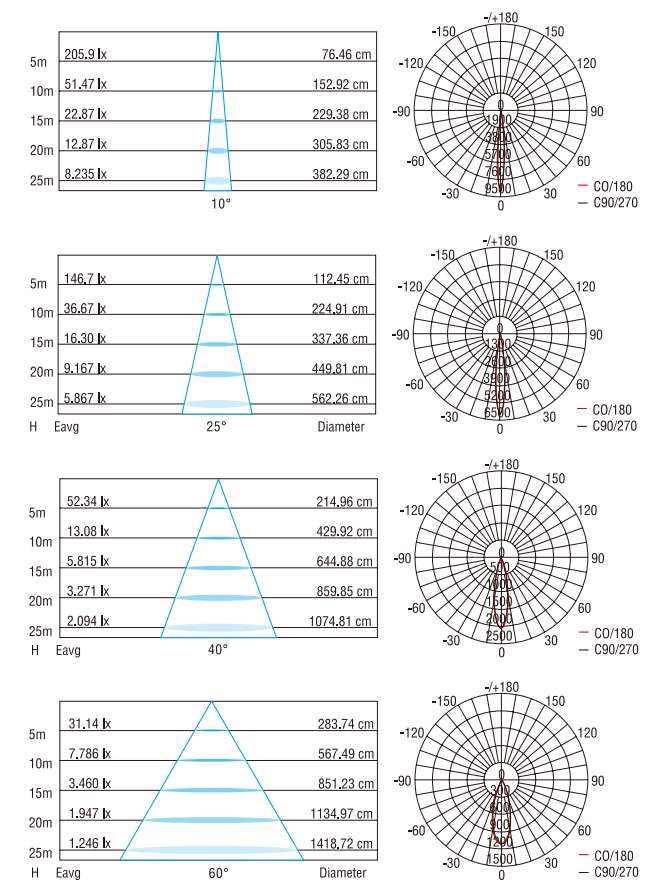

EFX-XJRH2-6

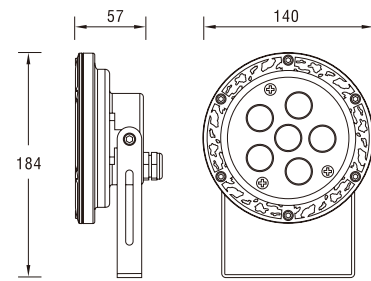

Product Dimension



EFX-XJRH2-3

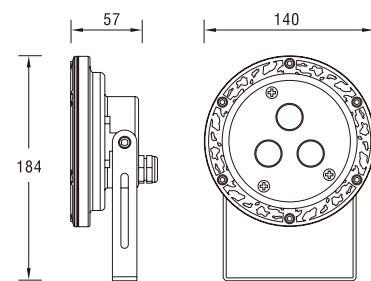

Product Dimension

Product Description

1. With the independent intellectual properties in design, fashionable and modern appearance, making the lights to be an artwork and perfectly combined with the environment.
2. The light adopts the high-pressure die-casting steel material. Surface treated with electrostatic plastic-sprayed in order to anti-aging, self-cleaning and corrosion-resistance.
3. The diffuser is made of toughened glass, impact resistance.
4. Light fitting can allocate white or single RGB. Various of color available. EFX-XDMX 512 control available.

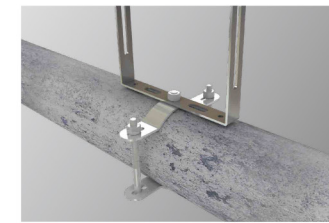

Installation 1 embrace hoop



Water proof connector design



Adjustable Angle

Light Distribution Curve

EFX-XJRH2-6

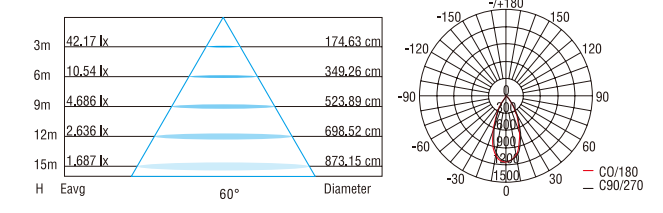
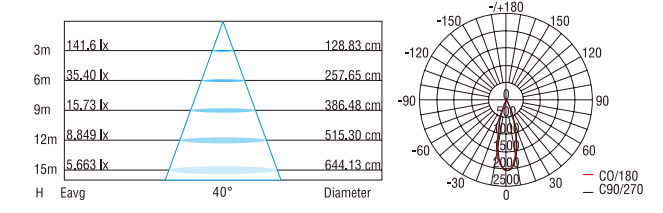
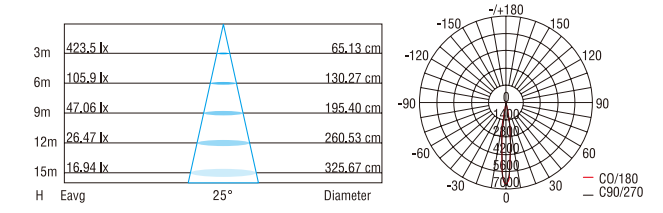
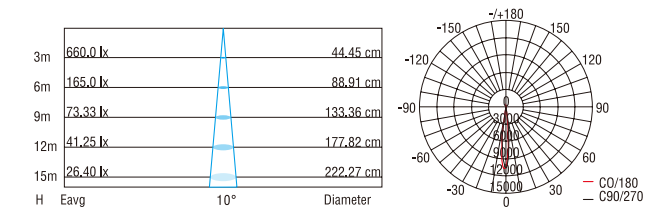

EFX-XJRH2-3

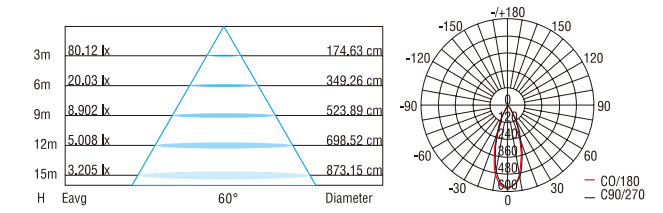
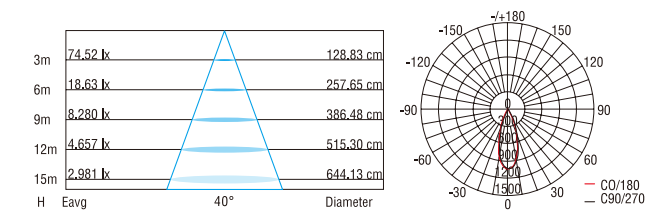
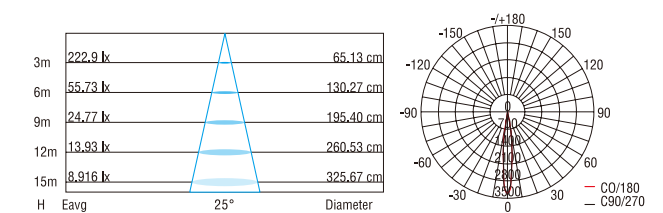
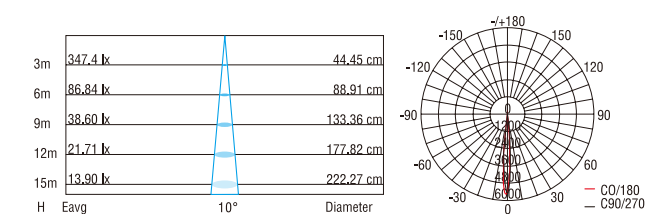

Wiring Diagram

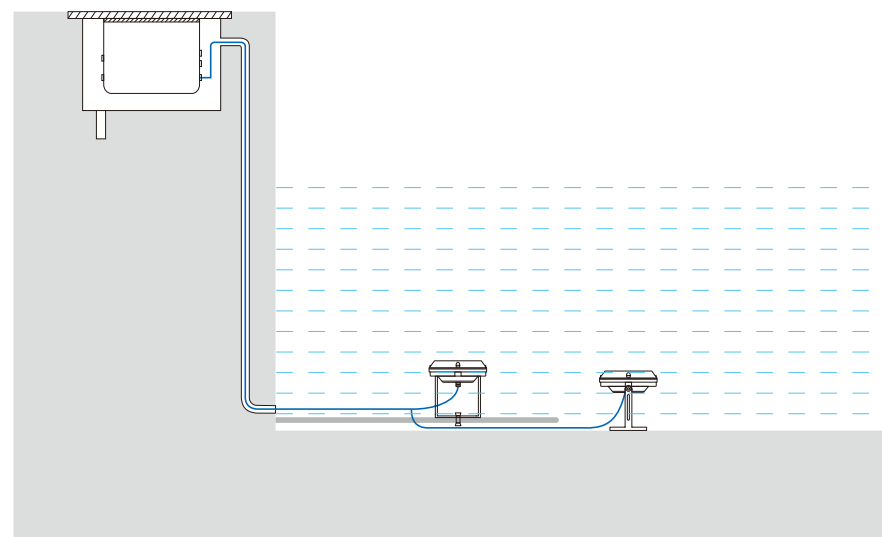
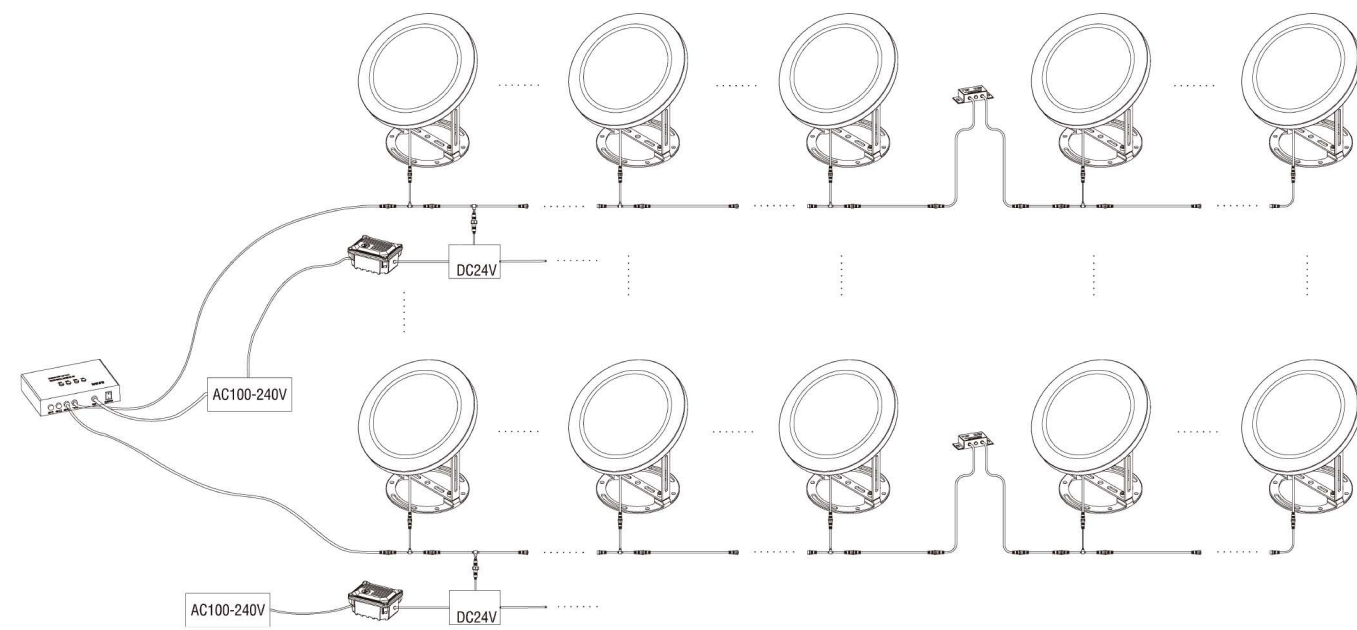

Accessories



Specification

Product Code	EFX-XJRH2-36	EFX-XJRH2-18	EFX-XJRH2-12	EFX-XJRH2-9	EFX-XJRH2-6	EFX-XJRH2-3
LED Quantity	36pcs	18pcs	12pcs	9pcs	6pcs	3pcs
Rated Power	36W	18W	12W	9.4W	7.2W	3.5W
Input Voltage	DC24V	DC24V	DC24V	DC24V	DC24V	DC24V
Color	RGB	RGB	RGB	RGB	Single	Single
Control Mode	DMX512	DMX512	DMX512	DMX512	CC	CC
Beam Angle	10°25°40°60°	10°25°40°60°	10°25°40°60°	10°25°40°60°	10°25°40°60°	10°25°40°60°
Lamp Luminous Flux	1649 lm	871lm	547 lm	422 lm	472 lm	248 lm
Temperature of Working Condition	-25°C~50°C	-25°C~50°C	-25°C~50°C	-25°C~50°C	-25°C~50°C	-25°C~50°C
Humidity of Working Condition	10%~90%	10%~90%	10%~90%	10%~90%	10%~90%	10%~90%
Life	> 30000H	> 30000H	> 30000H	> 30000H	> 30000H	> 30000H
Net Weight	4.0	2.9	1.1	1.1	0.8	0.8
Gross Weight	4.2	3.1	1.3	1.3	1.0	1.0
Protection Grade	IP68	IP68	IP68	IP68	IP68	IP68
Packing Size (mm)	310×220×371	260×186×312	224×186×305	224×186×305	200×130×285	200×130×285

All parameters are measured at 25°C ambient temperature, 35% humidity experimental environment

LED Underwater Light

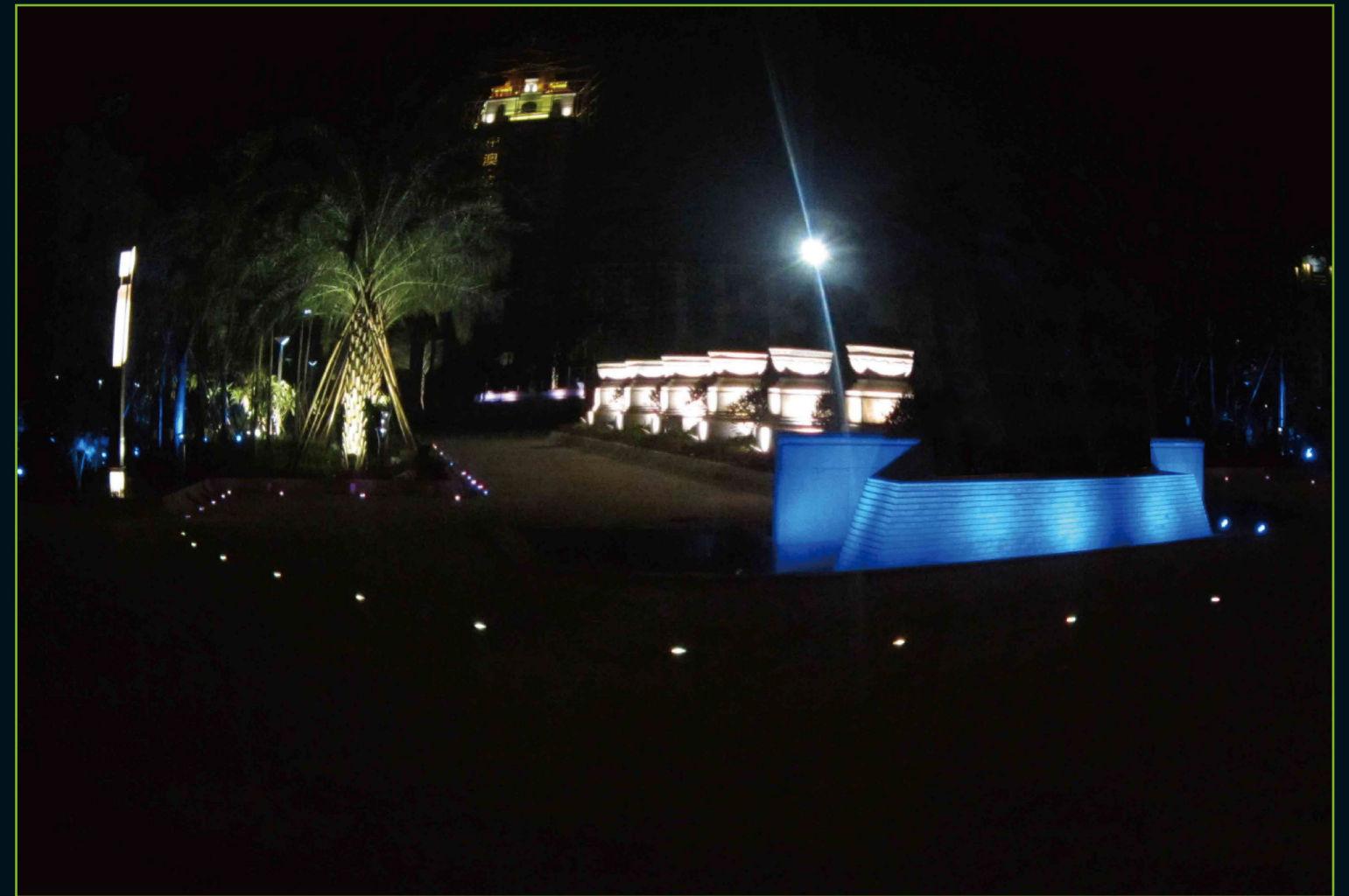
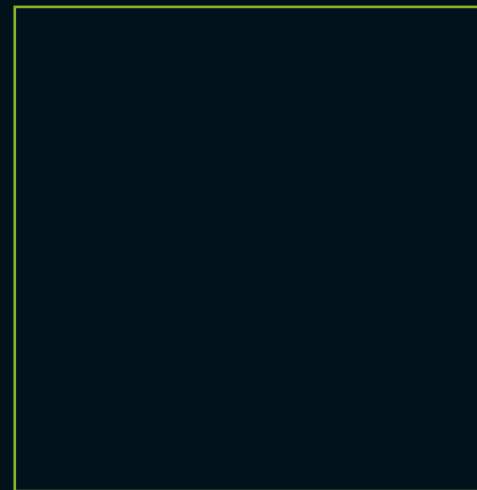
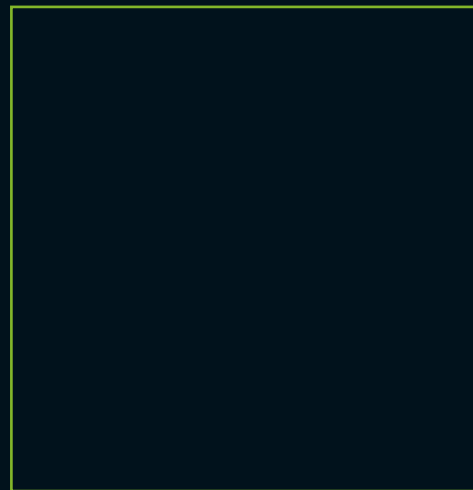
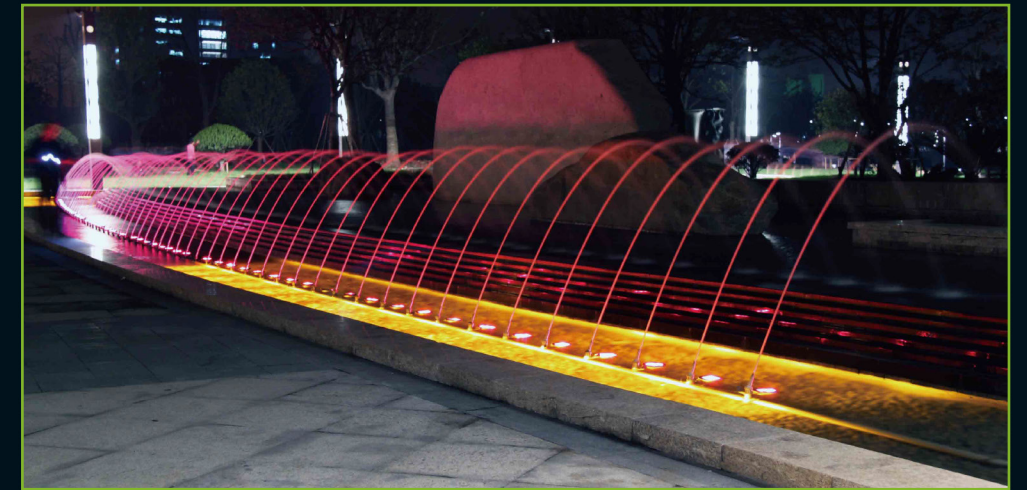
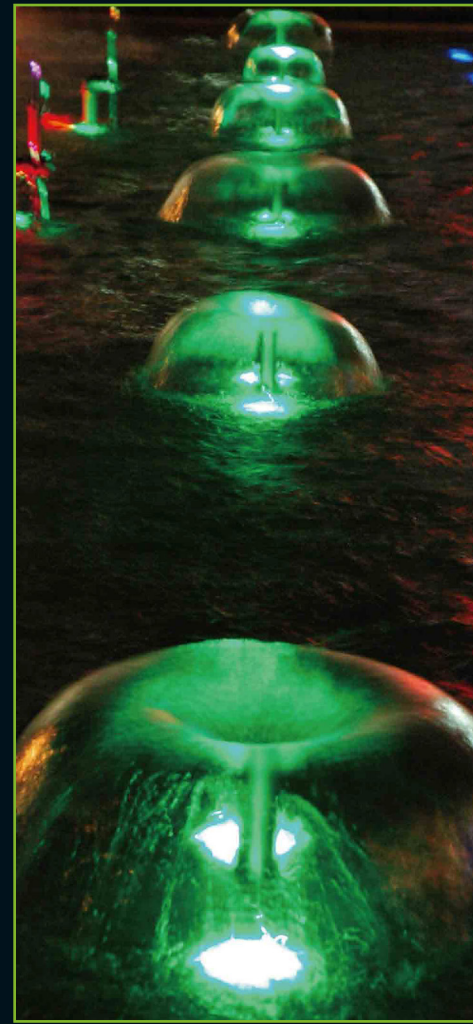

www.eco-fx.co.uk

EcoFX
LED lighting solutions

Office 1, 192 Shoreham Street
Sheffield S1 4SQ, UK
T: +44(0) 114 321 9610
E: enquiries@eco-fx.co.uk

Global Partner

Eco-FX
Smarter LED Lighting Solutions
Australia

